

If any questions about mortising occur please call Brusso at 212-337-8510

ST-80

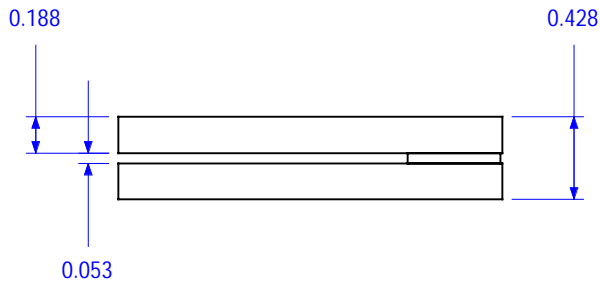
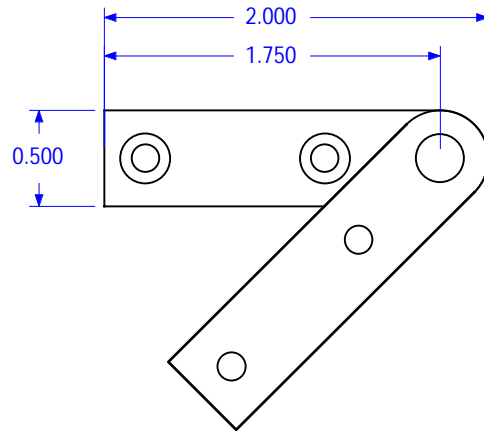

Do not scale drawing

Questions- Call before mortising 212-337-8510

BRUSSO ® <i>Incorporated</i> PRECISION HARDWARE	© 1983-2003 Brusso Inc. 20 Vandam Street New York, NY 10013 212 337 8510 Fax 212 337 9840	Product: ST-80 Straight Pivot Cabinet Hinge			Revision: a
		Component: Template			File Name: ST-80 Straight Pivot -Rev a
Tolerances unless otherwise specified: Machined features fraction +/- 1/64, Decimal .XXXX +/- .0005, .XXX +/- .005, Angular +/- 1 Degree, Hole Diameter +.003/- .002		Catalog Number: ST-80	Drawn by: JM	Checked by: AS	Sheet: 1 of 4
		Scale: 1:1	Date: 05/21/03	Date: 06/06/03	